

**BROMIC**<sup>®</sup>  
HEATING



PLATINUM  
**SMART-HEAT™ ELECTRIC  
MARINE**

---

# PLATINUM SMART-HEAT™ ELECTRIC MARINE

---

Made in high-quality, AISI316-grade stainless-steel, our Platinum Smart-Heat™ Electric Marine heaters were specifically engineered to provide superior resistance to the corrosive elements of marine and coastal environments. Available in a white or black finish, the translucent ceramic glass screen spreads radiant heat evenly across large areas while minimizing light emission.

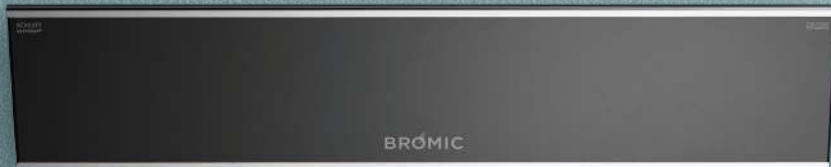

**2300W, 3400W & 4500W SERIES**  
BLACK | WHITE



**2300W, 3400W & 4500W SERIES**  
BLACK | WHITE



**VERSATILE MOUNTING SOLUTION**

Minimal ceiling recess clearance required. Flush mounted design aesthetics.

**HIGH PERFORMANCE STAINLESS-STEEL CONSTRUCTION**

Premium 316 grade stainless-steel suitable for marine and coastal environments.

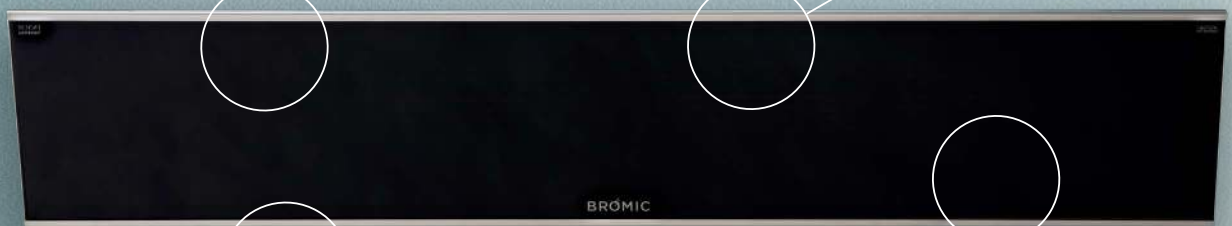

**CLEAN, COMPACT AND ELEGANT DESIGN**

Minimized light emissions and easy to clean in a black or white finish.

**SEALED ELEMENT**

Sealed compartment with thin film elements to prevent corrosion.



**COMPATIBLE WITH SMART-WIRELESS TECHNOLOGY**

EXTEND YOUR COMFORT OUTDOORS  
WITH THE SUPERIOR HEAT AND  
AWARD-WINNING DESIGN OF OUR  
SMART-HEAT™ OUTDOOR HEATERS.





# PLATINUM SMART-HEAT™ ELECTRIC

MODEL NUMBER	2300W SERIES	3400W SERIES	4500W SERIES
PRODUCT CODES PLATINUM ELECTRIC MARINE	BH0320011   BH0320013	BH0320012   BH0320014	BH3622002   BH3622003
FUEL TYPE	ELECTRIC	ELECTRIC	ELECTRIC
COLOR	BLACK   WHITE	BLACK   WHITE	BLACK   WHITE
HEAT AREA	6M <sup>2</sup>	10M <sup>2</sup>	12M <sup>2</sup>
RATED CURRENT	220 - 240V/9.6A	220 - 240V/14.2A	220 - 240V/18.8A
MINIMUM FLOOR CLEARANCE	WALL 1800MM   CEILING 2400MM		

MOUNTING OPTIONS			
CEILING MOUNT	INCLUDED	INCLUDED	INCLUDED
WALL MOUNT	INCLUDED	INCLUDED	INCLUDED
RECESS KIT   FLUSH MOUNT	✓	✓	✓
CEILING RECESS KIT PRODUCT CODES	BH3130032	BH3130027	BH3623001
NEW RECESS KIT   LOW CLEARANCE	✓	✓	-
LOW CLEARANCE RECESS KIT PRODUCT CODES	BH3623011	BH3623010	-
CEILING POLE EXTENSION	✓	✓	✓
CEILING POLE (600MM) MARINE PRODUCT CODE	BH3130056	BH3130056	BH3623022
CEILING POLE (1200MM) MARINE PRODUCT CODE	BH3130057	BH3130057	BH3623023
FREESTANDING	-	-	-

CONTROL OPTIONS			
ON   OFF	✓	✓	✓
ON   OFF PRODUCT CODE	BH3130019-2	BH3130019-2	BH3130019-2
DIMMER	✓	✓	✓
DIMMER PRODUCT CODE	BH3130020-3	BH3130020-3	BH3130020-3
MASTER REMOTE *	✓	✓	✓
MASTER REMOTE PRODUCT CODE	BH3130021-2	BH3130021-2	BH3130021-2

\* Controls up to six zones of heaters with unlimited heaters per zone from a single control. Works only with dimming controllers. Control operates within 30m of heaters.

Measurements displayed within this document are for reference only, for complete requirements see the installation/user manual. Bromic takes no responsibility for incorrect or non-compliant installations. All measurement in this document are displayed in mm.

## PRODUCT MEASUREMENTS

2300W

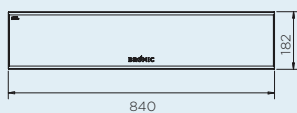

3400W

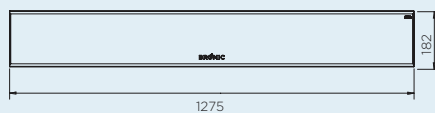

4500W

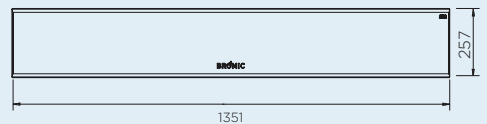

## CEILING RECESS KIT

CEILING RECESS FRAME 2300W

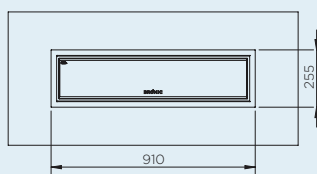

CEILING RECESS FRAME 3400W

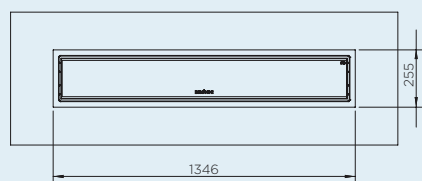

CEILING RECESS FRAME 4500W

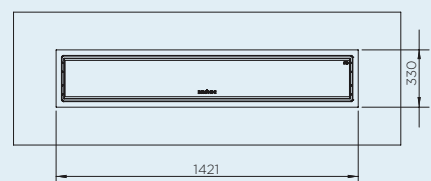

## CEILING CAVITY GUIDE

### MINIMUM CAVITY SIZE FOR 2300W, 3400W & 4500W MODELS

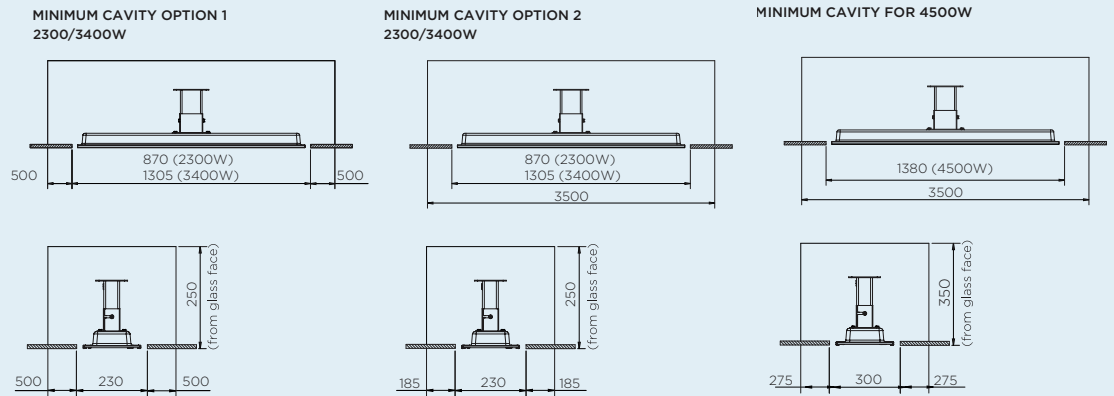

### LOW CLEARANCE RECESS KIT 2300/3400W

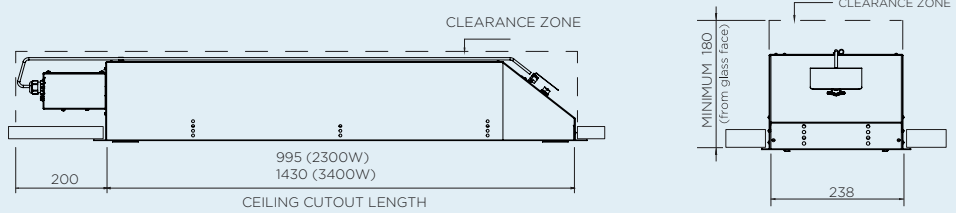

## HEAT AREA

\*HEAT AREA DEPENDENT ON AMBIENT TEMPERATURE AND WIND. OPTIMUM CONDITIONS EXPERIENCED AT APPROX 15.5°C AND IN A LOW WIND COVERED ENVIRONMENT.

**2150W SERIES**  
HEATING APPROXIMATELY 6M<sup>2</sup>  
2150W HEATING POWER

**3150W SERIES**  
HEATING APPROXIMATELY 10M<sup>2</sup>  
3150W HEATING POWER

**4150W PLATINUM**  
HEATING APPROXIMATELY 12M<sup>2</sup>  
4150W HEATING POWER

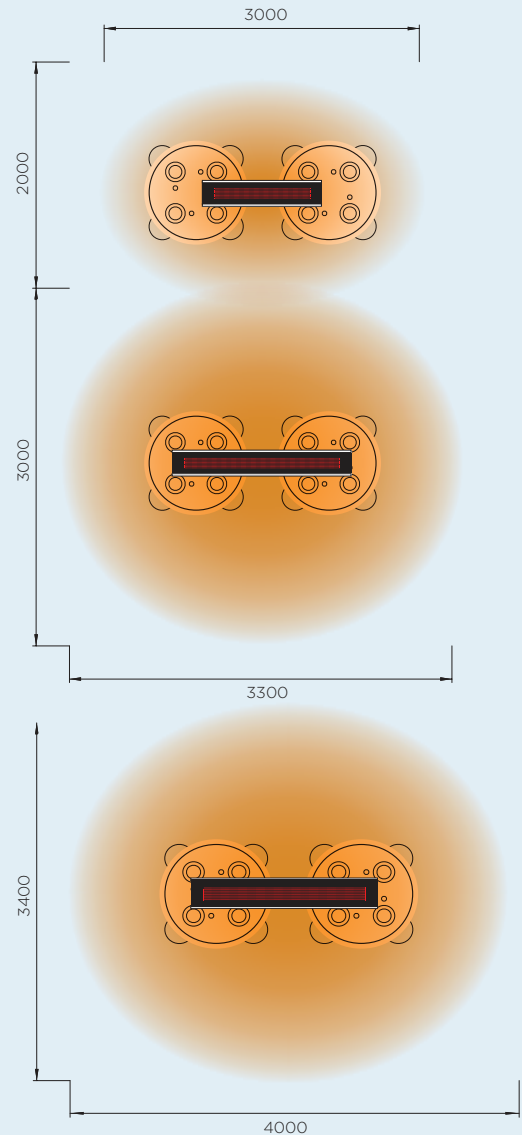

## EXPLORE THE POSSIBILITIES

With the Bronic Smart-Heat™ complimentary design service, designing a solution to optimize heating for your outdoor spaces is simple.

**BROMIC.COM**

**ASIA PACIFIC | NORTH AMERICA | EUROPE**

Bronic pursues a policy of continuing improvement in design and development of its products. The right is therefore reserved to vary specifications without notice.

11.2022